

HCT | Skincare

2021 CATALOG

CONFIDENTIALITY AGREEMENT

The Presentation contained on the following pages are confidential and proprietary information owned exclusively by HCT Packaging, Inc. or one of its affiliates ("HCT").

By viewing the Presentation, you are acknowledging and agreeing, on behalf of yourself and any third parties you represent, to hold in strict confidence any and all information and materials provided to you by HCT in connection with the Presentation, whether disclosed orally or in writing ("HCT Information"). You further agree that you will not use, disclose or otherwise exploit the HCT information without HCT's express written consent. In the event of any breach by you or your agents of the promises contained in this paragraph, HCT intends to vigorously enforce its rights with respect to the HCT information by pursuing all legal and equitable remedies available to it, including seeking the imposition of sanctions.

TABLE OF CONTENTS

- > HCT SKINCARE INTRODUCTION
- > PUMPS - AIRLESS/NON-AIRLESS
- > JARS
- > STICKS
- > DROPPERS
- > ZAMAC COMPONENTS
- > MISC (TOTTLES, CUSHION COMPACTS)
- > INNOVATION

HOT & NEW = new component

 = Eco Modern Approach
eco/sustainable component



HCT SKINCARE

HCT SKINCARE IS AN INDUSTRY LEADER IN OFFERING INNOVATIVE FORMULAS AND PACKAGING TO SERVE THE DIVERSE NEEDS OF CLIENTS.

Whether it's clean beauty, K-Beauty, or CBD skincare, HCT's expertise in skincare packaging delivers a truly unique 360° solution.

In addition to the incredible stock library of color components, HCT Group also has a wide selection of skincare componentry inclusive of pumps, tubes, droppers and more. HCT Skincare offers customers a wide array of packaging options that keep formulas protected and pure.

END-TO-END, TURNKEY SOLUTIONS THAT TAKE BEAUTY BRANDS TO THE NEXT LEVEL.

OUR FULL-SERVICE CAPABILITIES INCLUDE:

> IN-HOUSE CREATIVE TEAM

Industrial Design
Graphic Design
Engineering
Prototyping

> IN-HOUSE MANUFACTURING

3 Plastic injection molding factories
3 Fill and assembly factories
1 Metal injection molding factory
1 Electroplating factory
1 Airless systems factory
1 Brush factory
1 Bulk manufacturing facility

> CUSTOM BEAUTY TOOLS & ACCESSORIES

Synthetic brushes	Skincare tools
Natural brushes	Tweezers
Silicone brushes	Nail tools
Applicators	Lashes
Cut and sew bags	Lash curlers
Sponges	Mirrors

> GLOBAL FOOTPRINT

> FORMULATION R&D

> WORLD'S LARGEST STOCK CATALOG

> CUSTOM BRAND STRATEGY

> CUSTOM TOOLING AND MOLDS

> WHITE SPACE IDENTIFICATION & TREND FORECASTING

> REGULATORY ASSISTANCE & PATENT ENFORCEMENT

> COMPATIBILITY & STABILITY TESTING

> QUALITY CONTROL

> CUSTOMS & CLEARANCE

> SHIPPING & LOGISTICS

WHAT IS AIRLESS?

AIRLESS DEFINITION

“An airless packaging is a non-pressurized, tamper-proof, dispensing system, combining a mechanical pump with an airless filled and sealed container, which delivers the product with no intake of air. The container is either deformable, or rigid, with a piston or a pouch.”

AIRLESS ADVANTAGES

- ✓ Good restitution rate for formulas
- ✓ No contact between outside air or formula
- ✓ Usage in any position

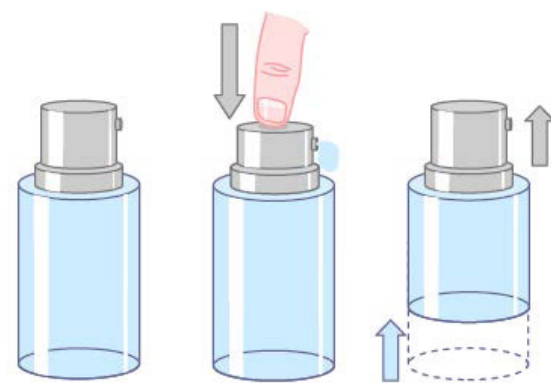

AIRLESS WORKING PRINCIPLE

Airless dispensers work without allowing air to get back into the bottle. It is characterized by a changing volume of the bulk container.

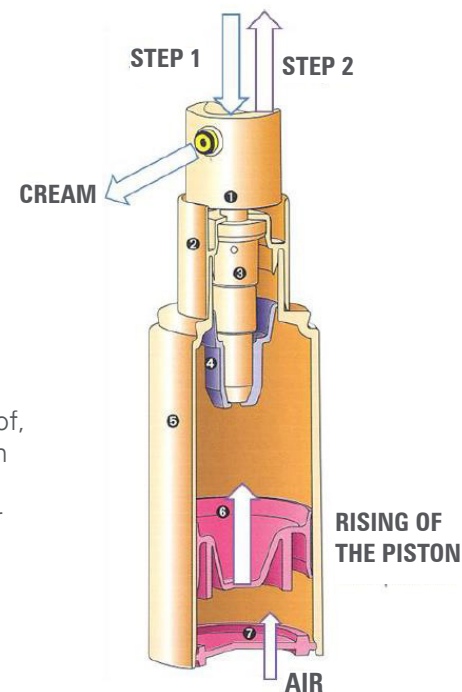

1 VOLUME OF EXPELLED FORMULA = 1 movement of piston to compensate the expelled formula.

AIRLESS BOTTLE TYPE

PISTON AIRLESS

Principally round, but also available in oval and square as well. When the piston is rising, air enters at the bottom of the bottle (hole vent) to equilibrate the pressure due to the diminution of the formula when it's expelled. No air contact with formula.

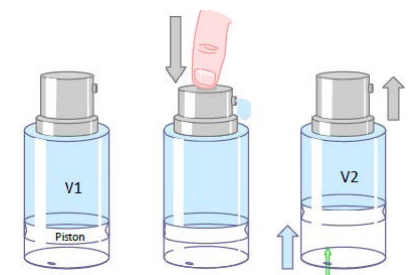

POUCH AIRLESS

Principally, a squeezable pouch is placed into a rigid bottle to keep the external shape during usage. To equilibrate the pressure due to the diminution of the formula when it's expelled, the air enters into the bottle in-between the pouch and the bottle. No air contact with formula.

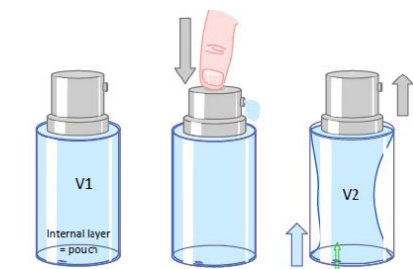

PUMP TUBE AIRLESS

Principally, a plastic tube with or without EVOH layers are used. An airless engine on top of a plastic tube will squeeze the tube during usage. No air contact with formula. External tube shape not maintained.

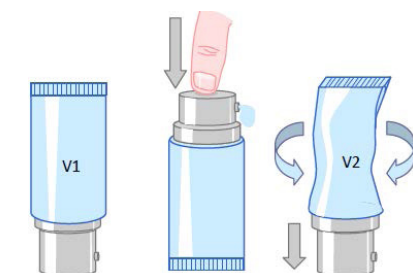

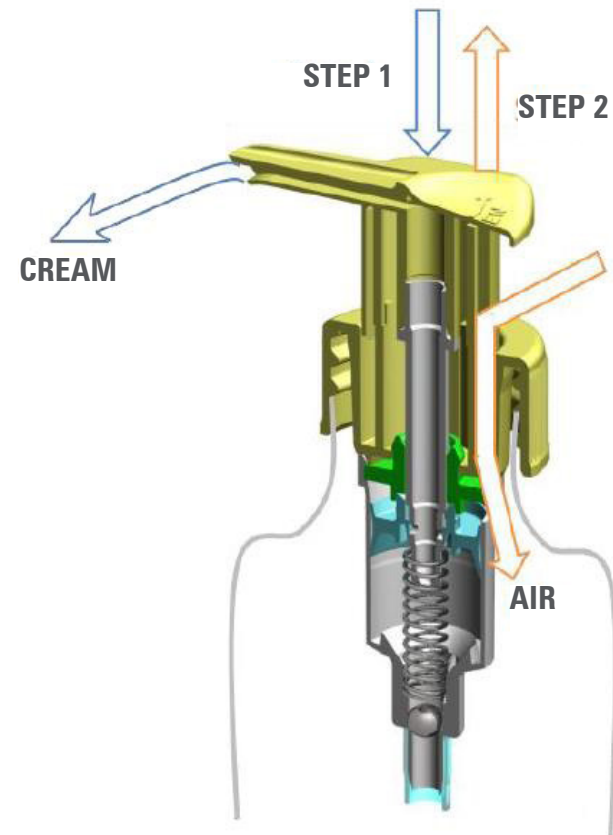

DISPENSER SYSTEM

DISPENSER TYPE

- Atmospheric Pump
- Mist Pump
- Foam Pump

DISPENSER WORKING PRINCIPLE

Air movement within the pump and bottle is a basic principle for the dispenser to work. For one dosage of formula getting out, an equal air quantity enters back into the bottle by the hole vent.

1 VOLUME OF EXPELLED FORMULA =
1 volume of air entering the bottle

SINGLE WALL
COMPONENTS



HCT01-10

FEATURES

This airless pump is perfect for pairing with essence and lotion formulas.

- > **MATERIALS**
Overcap: SAN/ABS/PN
Shoulder: PP/AL
Bottle: SAN
Base: ABS

- > **FILL VOLUME**
15mL, 20mL, 25mL, 30mL,
35mL, 40mL, 45mL, 50mL



HCT01-20

FEATURES

This airless pump is perfect for pairing with essence and lotion formulas.

- > **MATERIALS**
Overcap: SAN/ABS/PN
Shoulder: ABS
Bottle: SAN
Base: ABS

- > **FILL VOLUME**
15mL, 20mL, 25mL, 30mL,
35mL, 40mL, 45mL, 50mL



HCT01-40

FEATURES

This airless pump is perfect for pairing with essence and lotion formulas.

- > **MATERIALS**
Cap: PN
Button: PP
Collar: PP
Bottle: PP
Disc: ABS

- > **FILL VOLUME**
15mL, 30mL, 50mL



HCT07-8010

FEATURES

This airless pump is perfect for on-the-go usage. Its mono-material design is made from recyclable material.

> MATERIALS

Cap: PP/PN
Pump: PP
Shoulder: PP
Bottle:
Inner: PP
Outer: PP/PN

> FILL VOLUME

10mL

HCT07-50

FEATURES

This airless pump is perfect for on-the-go usage. Its mono-material design is made from recyclable material.

> MATERIALS

Cap: PP
Pump (button): PP
Pump (collar): PP
Bottle: PP

> FILL VOLUME

5mL, 10mL, 15mL

HCT11-10

FEATURES

This airless pump is perfect for on-the-go usage. Its mono-material design is made from recyclable material.

> MATERIALS

Cap: PP
Pump (actuator): PP
Pump (collar): PP
Bottle: PP

> FILL VOLUME

5mL, 7mL, 10mL, 15mL



HCT105-0

FEATURES

This airless pump includes a **shut off nozzle** to maintain an airtight seal, preventing any residue from formula to leak.

- > **MATERIALS**
- Cap: PETG
- Pump (actuator): PP
- Pump (collar): ABS
- Pump (nozzle): PP
- Bottle: PETG
- Bottle Base: ABS
- Piston: PE

- > **FILL VOLUME**
- 30mL, 35mL, 40mL, 45mL, 50mL



HCT101-0

FEATURES

This airless pump includes a **shut off nozzle** to maintain an airtight seal, preventing any residue from formula to leak.

- > **MATERIALS**
- Pump (actuator): ABS
- Pump (collar): ABS
- Pump (nozzle): PP
- Bottle: SAN or PETG
- Bottle Base: ABS
- Piston: PET

- > **FILL VOLUME**
- 15mL, 20mL, 25mL, 30mL, 35mL, 40mL, 45mL, 50mL



HCT07-30

FEATURES

This jumbo airless pump is perfect for pairing with moisturizers and sun care formulas.

- > **MATERIALS**
- Overcap: PP
- Shoulder: ABS
- Button: ASA
- Bottle: PP

- > **FILL VOLUME**
- 15mL, 30mL, 50mL, 100mL



HCT06-40

FEATURES

This airless pump features an overcap-less design, allowing for a sleeker look.

- > MATERIALS
 - Button: ASA
 - Shoulder: ABS
 - Bottle: SAN/ABS/PP
 - Base: ABS/PP

- > FILL VOLUME
 - 30mL, 50mL, 100mL, 120mL, 150mL



HCT07-40

FEATURES

This airless pump features an overcap-less design, allowing for a sleeker look.

- > MATERIALS
 - Pump (button): ASA
 - Pump (collar): ABS
 - Bottle: PP

- > FILL VOLUME
 - 15mL, 30mL, 50mL



**HCT10H-20F (PUMP)
HCT20-050-07 (BOTTLE)**

FEATURES

These pumps are perfect for family products, featuring a large fill as well as a travel appropriate size. The sleek design allows for a fine mist.

ECO - PCR available for bottles

- > MATERIALS
- Cap: PP
- Pump (Actuator): PP
- Pump (Collar): PP
- Bottle: PET

- > FILL VOLUME
- 30mL, 50mL

**HCT8A-42 (PUMP)
HCT42-100-07 (BOTTLE)**

FEATURES

These foaming pumps are available in a variety of mesh options for various formula pairings.

ECO - PCR available for bottles

- > MATERIALS
- Cap: PP
- Pump (Actuator): PP
- Pump (Collar): PP
- Bottle: PET

- > FILL VOLUME
- 100mL, 150mL

**HCT4D-24 (PUMP)
HCT24-150-04 (BOTTLE)**

FEATURES

This pump features a sleek design, and is perfect for toner and makeup remover formulas.

ECO - PCR available for bottles

- MATERIALS
- Cap: PP
- Pump Actuator/Nozzle: PP
- Pump Collar: PP
- Bottle: PET

- FILL VOLUME
- 150mL, 200mL

DOUBLE WALL
COMPONENTS

HOT & NEW



HCT-G01

FEATURES

New hexagon shape! This airless pump utilizes telescoping for a twist on/off feature.

- > MATERIALS
Pump (button): PP
Pump (collar): ABS
Outer Bottle: PMMA
Inner Bottle: PE

- > FILL VOLUME
15mL, 30mL, 50mL

HCT-G01A

FEATURES

This airless pump features an intuitive on-off twist locking mechanism to prolong formula freshness.

- > MATERIALS
Cap: ABS
Outer Bottle: AS
Inner Bottle: PP

- > FILL VOLUME
15mL, 30mL, 50mL

HOT & NEW



HCT07-20

FEATURES

This jumbo airless pump is perfect for pairing with moisturizers and sun care formulas.

> MATERIALS
 Button: PP
 Overcap: PN/PP/ABS
 Shoulder: PP
 Outer Bottle: SAN
 Inner Bottle: PP

> FILL VOLUME
 30mL, 50mL

HCT06-20

FEATURES

This is part of the jumbo series and is available in various sizes.

> MATERIALS
 Pump (button): ASA
 Pump (shoulder): ABS
 Bottle: SAN/PP
 Disc: ABS/PP

> FILL VOLUME
 30mL, 45mL (50mL),
 120mL

HOT & NEW



HOT & NEW



HCT05-30

FEATURES

New refillable twist airless pump/bottle.

- > MATERIALS
 - Pump (button cover): PN
 - Pump (button): PP
 - Outer Bottle: PN
 - Inner Bottle: PP
 - Base: ABS

- > FILL VOLUME
 - 30mL, 50mL

HCT05-3130

FEATURES

Refillable 130mL diptube.

- > MATERIALS
 - Pump Cover: PN
 - Pump Button: PP
 - Inner Bottle: PETG
 - Outer Bottle: PN
 - Bottle Base: ABS

- > FILL VOLUME
 - 130mL

HCT05-10

FEATURES

This refillable airless pump features a dual structure, allowing for consumers to reuse the pump after product use. The overcap-less design allows for a sleeker look.

- > MATERIALS
 - Button: ASA
 - Outer Bottle: ABS
 - Inner Bottle: PP
 - Base: ABS

- > FILL VOLUME
 - 30mL, 50mL

HOT & NEW



HCT-BF02

FEATURES

A unique shape that is available as a family kit with various sizes including a jar.

- > MATERIALS
 - Cap: PMMA
 - Pump (actuator): PP
 - Pump (collar): ABS
 - Inner Bottle: PE
 - Outer Bottle: PMMA

- > FILL VOLUME
 - 30mL, 60mL, 120mL

HCT33-10

FEATURES

This airless pump design features a double wall, perfect for cream and powder formulas.
*120ml is a dip tube pump

- > MATERIALS
 - Overcap: PN
 - Shoulder: ABS
 - Outer Bottle: PN
 - Inner Bottle: PP/PETG

- > FILL VOLUME
 - 30mL, 50mL, 120mL*

JARS



HCTCPP10B

FEATURES

This jar is great for any brand looking for simplicity and sustainability. It's mono-material design is made from recyclable material.

> MATERIALS
Cap: PP
Jar: PP

> FILL VOLUME
5mL, 7mL, 10mL

HCTCPP

FEATURES

This jar offers a luxe, sustainable design, with a PP double wall.

> MATERIALS
Cap: PP
Outer Jar: PP
Inner Jar: PP
Inner Lid: LDPE

> FILL VOLUME
30mL, 50mL,
80mL, 100mL

ECO PP 50ML

FEATURES

Thick walled design, providing a high-end premium look and feel.

MATERIALS
Outer Cap: PP
Screw Cap: PP
Liner: PE
Sealing Disc: PP
Jar (outer/inner): PP

FILL VOLUME
50mL



HCTCPP 100F

FEATURES

This jar offers options – available in a flip top, or a screw-on cap.

> MATERIALS

Cap: PP
Outer Jar: PP
Inner Jar: PP
Inner Lid: LDPE

> FILL VOLUME

100mL, 120mL,
150mL, 200mL



HCTCPP 200

FEATURES

This jar offers a luxe, sustainable design, with a PP double wall.

> MATERIALS

Cap: PP
Outer Jar: PP
Inner Lid: LDPE

> FILL VOLUME

100mL, 200mL



HCTCY -U

FEATURES

This jar features a luxe feel with a double wall, and is available for a family series.

- > MATERIALS
 - Outer Cap: PMMA or ABS
 - Inner Cap: ABS or PP
 - Outer Jar: PMMA
 - Inner Jar: PP
 - Inner Lid: LLDPE

- > FILL VOLUME
 - 15mL, 30mL, 50mL, 80mL, 100mL



HCTCY50-U REFILLABLE

FEATURES

This jar offers a luxe, sustainable design, with a refillable inner pod that can be easily popped out and replaced.

- > MATERIALS
 - Outer Cap: PMMA or ABS
 - Inner Cap: ABS or PP
 - Outer Jar: PMMA
 - Inner Jar: PP
 - Inner Lid: LLDPE

- > FILL VOLUME
 - 50mL



HCTN

FEATURES

This jar offers a luxe, sustainable design, with a double walled cap. The jar is made from recyclable material and should be separated from the cap when recycling.

- > MATERIALS
 - Outer Cap: PETG or ABS
 - Inner Cap: PP
 - Jar: PP
 - Inner Lid: LLDPE

- > FILL VOLUME
 - 15mL, 30mL, 50mL



DOUBLE JAR

FEATURES

Two full size jars in one component, making it ultra convenient for on-the-go use.

> MATERIALS
PMMA

> FILL VOLUME
7.4mL, 17.21mL

HOT & NEW



HCT-BF02

FEATURES

This jar features a luxe feel with a double wall, and is available for a family series.

> MATERIALS
Cap: PMMA
Liner: PE
Inner Jar: PP
Outer Jar: PMMA

> FILL VOLUME
30mL, 50mL

STICKS

HOT & NEW



HOT & NEW



ECO PET STCK

FEATURES

This mono-material design is made from recyclable material.

> MATERIALS

Base: PET
Outer: PET
Cup: PET
Shell: PET
Cap: PET

> FILL VOLUME

10g

STRAIGHT SIDED MINI BALM

FEATURES

Option for this component to be molded in clear or opaque PETG.

> MATERIALS

Cap: PETG
Screw: PETG
Body: PETG
Cup: POK

> FILL VOLUME

5mL



HCT18-3010

FEATURES

Dial-less stick that is perfect for sun care formulations.

- > MATERIALS
 - Cap: PP/PN
 - Inner cap: PP
 - Bottle: PP

- > FILL VOLUME
 - 10mL

HCT501-08P

FEATURES

This 2-in-1 stick is perfect for pairing with formulas that consumers will need to use together. Its airtight design is great for keeping formulas pure and fresh.

- > MATERIALS
 - Overcap (stick): PP
 - Body (stick): PP
 - Overcap (sponge): ABS
 - Sponge: NBR
 - Body (sponge): ABS

- > FILL VOLUME
 - 7mL
- > DIMENSION
 - 25mm



HCT3331-0

FEATURES

This stick features a unique design that is perfect for pairing with formulas that can be applied directly to the contours of the face, especially sun care.

- > MATERIALS
 - Cap: PP
 - Inner Lid: PP
 - Body: PP
 - Knob: PP

- > FILL VOLUME
 - 15mL, 20mL



HCT18-1020

FEATURES

Dial-screw system can be applied for deodorant and sun care.

- > MATERIALS
 - Cap: PP
 - Inner cap: PP
 - Handle: PP
 - Bottle: PP

- > FILL VOLUME
 - 20mL



HCT18-3016

FEATURES

Dial-screw system can be applied for deodorant and sun care.

- > MATERIALS
 - Cap: PP
 - Inner cap: PP
 - Handle: PP
 - Bottle: PP

- > FILL VOLUME
 - 16m



HCT18-3050

FEATURES

Dial-screw system can be applied for deodorant and suncare.

> MATERIALS

Cap: PP
Inner cap: PP
Handle: PP
Bottle: PP

> FILL VOLUME

50mL

HCT18-4020

FEATURES

Dial-screw system can be applied for deodorant and suncare.

> MATERIALS

Cap: PP
Inner cap: PP
Handle: PP
Bottle: PP

> FILL VOLUME

20mL

HCT18-1018

FEATURES

Dial-screw system can be applied for deodorant and suncare.

> MATERIALS

Cap: PP
Inner cap: PP
Handle: PP
Bottle: PP

> FILL VOLUME

18mL

DROPPERS



HOT & NEW



PURE 15ML GLASS CHUBBY

FEATURES

Compatible with nine different types of applicators in a variety of materials and shapes, making them a great option for multiple skincare formulas.

- > MATERIALS
 - Cap: Aluminum
 - Stem: POK
 - Wiper: LDPE/TPE
 - Bottle: Glass
 - Applicator Options: Metal, Ceramic, Flocked

- > FILL VOLUME
15mL

HCT18V-50RD-006

FEATURES

Heavy walled glass with a button dropper.

- > MATERIALS
 - Button: NBR/Silicone
 - Pipette: Glass
 - Wiper: PE
 - Botte: Glass

- > FILL VOLUME
50mL

HCT18HA-30RD-IOPE

FEATURES

This unique design can elevate a sustainable skincare line.

- > MATERIALS
 - Dropper: NBR/Elastomer/Silicone
 - Pipette: Glass
 - Wiper: PE
 - Botte: Glass

- > FILL VOLUME
30mL



HOT & NEW



HCT18HA-30RD-NONI

FEATURES

This unique glass design is perfect for elevating a sustainable skincare line.

- > MATERIALS
 - Dropper: NBR/Elastomer/Silicone
 - Pipette: Glass
 - Wiper: PE
 - Botte: Glass

- > FILL VOLUME
30mL

PP DROPPER

FEATURES

Mono-material PP, making it very easy for consumers to recycle.

- > MATERIALS
 - Inner Cap: PP
 - Bulb: 70% Adlfex, 30%PP
 - Bottle: PP
 - Pipette: PP

- > FILL VOLUME
30mL

HCT20A-30RD

FEATURES

This dropper features a heavy glass wall for an ultra luxe feel. The auto dropper is easy to use with a variety of formulas.

- > MATERIALS
 - Cap: PP
 - Inner cap: PP
 - Handle: PP
 - Bottle: PP

- > FILL VOLUME
30mL



HCTS30-SP

FEATURES

This unique glass design is perfect for elevating a sustainable skincare line.

- > MATERIALS
Bottle: PET or PETG
Plug: LDPE
Bulb: NBR/Silicone
Pipette: Glass

- > FILL VOLUME
30mL, 50mL

HCT-C01 30ML

FEATURES

Ability to add a custom color silicone bulb.

- > MATERIALS
Bottle: PET
Bulb: NBR/Silicone
Pipette: Glass

- > FILL VOLUME
30mL

TUBE COMPONENTS

PE & POLY-FOIL TUBES

TUBES

AVAILABLE TUBE SHAPES	DIAMETER IN MM (POLYFOIL IN GREY)									
	18	19	22	25	30	35	40	45	50	60
ROUND										
OVAL										

AVAILABLE CLOSURES	DIAMETER IN MM (POLYFOIL IN GREY)									
	18	19	22	25	30	35	40	45	50	60
STANDARD SCREW CAP										
FLIP TOP										
NOZZLE										
AIRLESS TIP										
LIP GLOSS										
AIRLESS PUMP										
ZAMAC TIP										



5 LAYER TUBE

1	LDPE	220 μm	± 10
2	ADMER	15 μm	± 5
3	EVAL	15 μm	± 5
4	ADMER	15 μm	± 5
5	LDPE	220 μm	± 10
TOTAL	TOLERANCE ± 5	490 $\mu\text{m} \pm 30$	

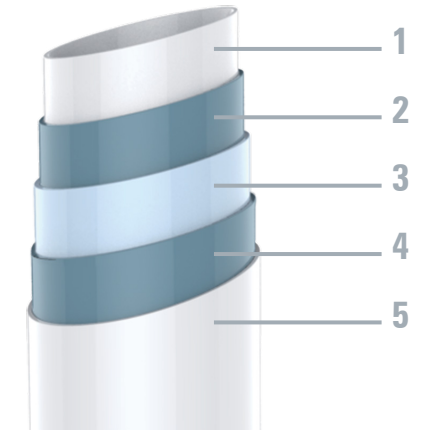

7 LAYER TUBE

1	PE	220 μm
2	ADMER	15 μm
3	PET	15 μm
4	ADMER	15 μm
5	AL	15 μm
6	ADMER	15 μm
7	PE	220 μm
TOTAL	LDPE	500 $\mu\text{m} \pm 20$

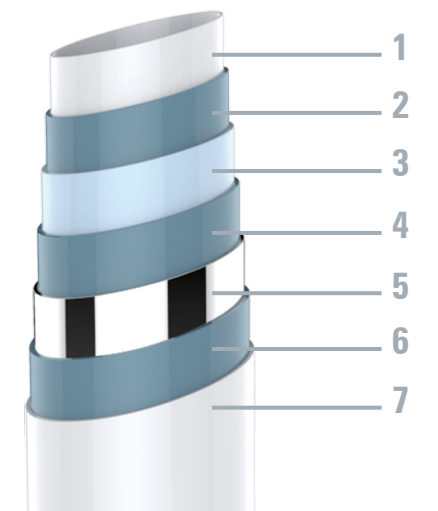

LAMINATE TUBES (PBL)

AVAILABLE TUBE SHAPES	DIAMETER IN MM							
	18	19	22	25	30	35	40	50
ROUND								
OVAL								

AVAILABLE CLOSURES	DIAMETER IN MM							
	18	19	22	25	30	35	40	50
STANDARD SCREW CAP								
FLIP TOP								
NOZZLE								
AIRLESS TIP								
LIP GLOSS								
AIRLESS PUMP								



STANDARD SCREW CAP



FLIP TOP



NOZZLE



AIRLESS TIP



LIP GLOSS



AIRLESS PUMP



LAMINATE TUBE (PBL)

1	POLYETHYLENE COEX.FILM	90 μ m
2	POLYETHYLENE LAMINATE	30 μ m
3	CO-EXTRUSION FILM	60 μ m
4	POLYETHYLENE LAMINATE	30 μ m
5	POLYETHYLENE COEX.FILM	160 μ m
TOTAL LAYER THICKNESS		370 μ m

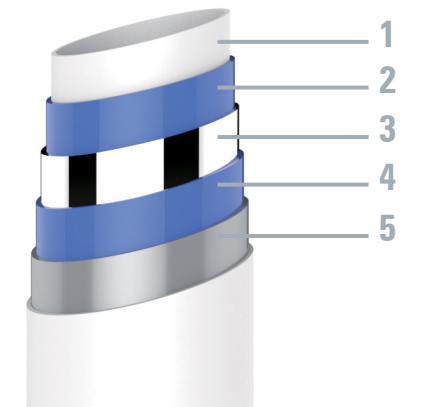

ALUMINUM TUBES (AT)

TUBES



CODE NAME	CAPACITY (g)	DIAMETER	SHAPE	LAYERS	TOTAL HEIGHT
AT13-R-S	5	13.3	ROUND	1	70-80
AT15-R-S	7-10	15.5	ROUND	1	72-106
AT16-R-S	10	16.5	ROUND	1	82-115
AT14-R-NP	18-25	19	ROUND	1	68-135
AT22-R-S	20-30	22	ROUND	1	85-120
AT25-R-S	30-50	25	ROUND	1	114-151
AT25-R-NP	30-50	25	ROUND	1	114-151
AT28-R-S	40-60	28	ROUND	1	115-160
AT28-R-NP	40-60	28	ROUND	1	115-160
AT30-R-S	50-80	30	ROUND	1	130-170
AT30-R-NP	50-80	30	ROUND	1	130-170
AT32-R-S	60-100	32	ROUND	1	150-180
AT32-R-NP	60-100	32	ROUND	1	150-170
AT35-R-S	60-120	35	ROUND	1	120-180



HCTP07-30

FEATURES

This airless pump tube is available in 25 mm and 35 mm diameters, for smaller and larger fills. It comes in various diameters and tube sleeve lengths, which will be dependent on targeted fill weight.

> MATERIALS

Overcap: PP
Pump: PP
Pump Shoulder: PP
Tube: Available in PE and Polyfoil

> FILL VOLUME

30mL – 60mL

DIMENSIONS

30mm

HCTP01-25

FEATURES

This airless pump tube is available in 30 mm and 35 mm diameters, for larger fills. The airless pump tube sleeve lengths will depend on the targeted fill weight.

> MATERIALS

Overcap: PP
Pump: PP
Pump Shoulder: PP
Tube: Available in PE and Polyfoil

> FILL VOLUME

30mL – 45mL

DIMENSIONS

25mm

HCTP04-35

FEATURES

This airless pump tube comes in various diameters and tube sleeve lengths, which is dependent on targeted fill weight.

> MATERIALS

Overcap: PP
Pump: PP
Pump Shoulder: PP
Tube: Available in PE and Polyfoil

> FILL VOLUME

40mL – 60mL

DIMENSIONS

35mm

HOT & NEW



PILLAR TUBE

FEATURES

Unique profile has an ergonomic button cap that makes dispensing product easy to do with one hand.

- > MATERIALS
UP Cap: PP
Disc Cap: PP
Tube: 5 Layer LPDE

- > FILL VOLUME
30mL, 50mL



FLAT RIBBON TUBE

FEATURES

Unique profile has an ergonomic snap-on cap that makes dispensing product easy to do with one hand. The product dispenses in a unique ribbon-like shape.

- > MATERIALS
Tube: 5-Layer LDPE
Cap/Inner Cap: PP
Nozzle: HDPE

- > FILL VOLUME
20-50mL
(fill depends on tube length)

ZAMAC
COMPONENTS

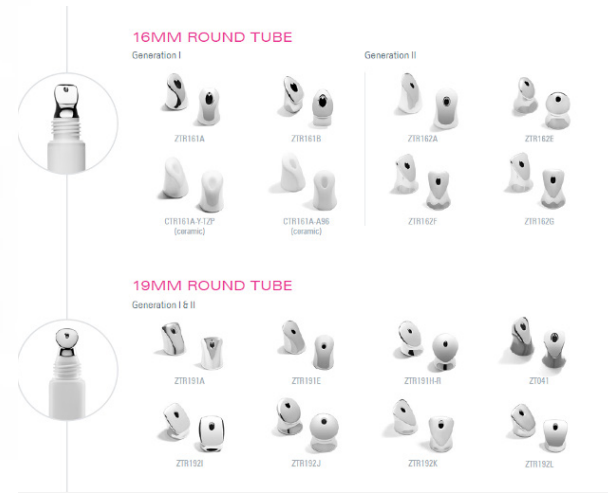

TUBES WITH ZAMAC TIPS

FEATURES

HCT's Cooling Tip Technology® can optimize your formula performance. There are different tube materials and diameters available with various ZAMAC tip options.

- > **MATERIALS**
Tube: PE/Polyfoil
Tip: ZTR162E Palladium

- > **DIAMETER**
D19mm



PRECISION DROPPER WITH ZAMAC APPLICATOR

FEATURES

Squeezable tube with a protective aluminum over shell for added durability.

- > **MATERIALS**
Over shell: Aluminum (Option with or without window)
Bottle: LDPE
Inner Cap: PP
Inner Tip: LDPE
Applicator: ZAMAC

- > **FILL VOLUME**
15mL

HOT & NEW



FORWARD PUMP

FEATURES

Ergonomic design replicating the touch of a finer that allows you to apply and press product directly onto the skin, while hugging the natural contours of the face.

- > **MATERIALS**
Outer Cap: PETG
Outer Actuator: PP
Inner Actuator: PP
Collar: ABS
Bottle: PETG
Applicator Options: PP or ZAMAC

- > **FILL VOLUME**
15mL



PULL DOWN ACTUATOR
WITH ZAMAC TIP

FEATURES

Combining airless technology with a unique dispensing system that makes product application easier than ever before.

- > MATERIALS
Tip: PETG or ZAMAC
Actuator: PP
Bottle: PP or PETG

- > FILL VOLUME
PP: 5mL, 7.5mL,
10mL, 15mL
PETG: 7mL, 15mL



SP PAM SERIES
WITH ZAMAC TIPS

FEATURES

Perfect for small, on-the-go formulas that require airless technology. Available with different metal tips that help target and cool specific areas.

- > MATERIALS
Overcap: PP (PAM Series), PETG (PAM-T Series)
Actuator: PP or PE
Shoulder: PP
Bottle: PP (PAM Series), PETG (PAM-T Series)

- > FILL VOLUME
5mL, 7mL, 7.5mL,
10mL, 15mL

HOT & NEW



**AIRLESS PEN WITH
ZAMAC TIP 1033B-14A**

FEATURES

Dispenses product by twisting the collar of the component.

> **MATERIALS**

- Cap: PETG
- Tip Holder: PP
- Outer Shoulder: ABS + SAN
- Bottle: PETG
- Bottle Piston: LLDPE
- Bottle Base: PP
- Tip: ZAMAC (shares all ZAMAC tips used with 19mm tubes)

> **FILL VOLUME**

10.6mL

**REFILLABLE AIRLESS PEN
1061BF-14A WITH ZTR191H-R**

FEATURES

Once product is used, the PP Bottle can be easily removed and replaced.

> **MATERIALS**

- Cap: PP
- Tip Holder: PP
- Body: PP
- Pump Piston: LLDPE
- Bottle: PP
- Tip: ZAMAC (shares all ZAMAC tips used with 19mm tubes)

> **FILL VOLUME**

6.6mL

MISC.
COMPONENTS



TWIST AND CLICK PENS

FEATURES

These click pens are available with different applicators, but all have a “twist and click” functions.

- > MATERIALS
 - Cap: PP
 - P-Cone: PP
 - Barrel: PP
 - Button: ABS
 - Holder: PP
 - Piston: PE
 - Cam: POM
 - Piston Rod: POM

- > FILL VOLUME
30mL – 60mL
- > DIMENSIONS
30mm



AIRLESS CRAYON

FEATURES

Ultra slim airless system, available with a pointed applicator for precise, targeted application, or a slanted applicator that is best for larger surface areas, such as lips or under the eyes.

- > MATERIALS
 - Cap: PP
 - Inner Tip: PP
 - Barrel: PP
 - Piston: LDPE
 - Bottle: PP
 - Pointed Applicator: TPE + PP
 - Slanted Applicator: TPE

- > FILL VOLUME
4tmL



PRECISION DROPPER

FEATURES

Squeezable tube with a protective aluminum over shell for added durability.

- > MATERIALS
 - Overshell: Aluminum (option w/ or w/o window)
 - Bottle: LDPE
 - Inner cap: PP
 - Inner tip: LDPE

- > FILL VOLUME
15mL



PUSH PEN (ROUND)

FEATURES

An easy to use button allows the user to have more control over the dosage. The 15mL option utilizes a double wall feature for a luxe feel that will truly protect your formula.

> MATERIALS

Cap: PP (5S, 30S, 50S & 150 Inner)
 Inner Cap: PP (150D): PP
 Nozzle: PP
 Container: PP (5S, 30S & 50S) (Inner: 15D)
 PETG (Outer 15D)
 Piston: LDPE
 Shoulder: ABS (15D, 30S & 50S)
 Pump: PP / TPR
 Button: ABS (15D, 30S & 50S)

> FILL VOLUME

5mL, 15mL, 30mL, 50mL

PUSH PEN (OVAL)

FEATURES

Engineless pump with an easy to use soft button that allows user to have more control over the dosage.

> MATERIALS

Flip Top Cap: PP
 Container: PP
 Piston: LDPE
 Pump: PP/TPR

> FILL VOLUME

15mL, 30mL, 50mL

HCTAa

FEATURES

This bottle is a unique design that is perfect for pairing with SPF and lotion formulas. The size is great for travel and on-the-go use.

> MATERIALS

Bottle: PE+Adhesive+EVOH
 Outer Cap: ABS or PP
 Inner Cap: PP
 Plug: LDPE

> FILL VOLUME

35mL, 50mL



HCTBe

FEATURES

This tottle is perfect for pairing with sun care formulas.

- > MATERIALS
Bottle: PE+Adhesive+EVOH
Cap: PP
Plug: LDPE

- > FILL VOLUME
8mL, 40mL, 50mL, 60mL,
80mL, 100mL, 150mL,
180mL



HCTLi

FEATURES

This tottle is perfect for pairing with sun care formulas.

- > MATERIALS
Bottle: PE+Adhesive+EVOH (3layers) or PE
Outer Cap: ABS or PP
Inner Cap: PP
Plug: LDPE

- > FILL VOLUME
8mL, 15mL, 35mL,
45mL, 60mL



HCTTa

FEATURES

This tottle is perfect for pairing with sun care formulas.

- > MATERIALS
Bottle: PE+Adhesive+EVOH
Cap: PP
Plug: LDPE

- > FILL VOLUME
30mL, 50mL, 75mL



HCTMa

FEATURES

This tottle is perfect for pairing with sun care formulas.

- > MATERIALS
Bottle: PE+Adhesive+EVOH (3 layers) or PE
Outer Cap: ABS or PP
Inner Cap: PP
Plug: LDPE

- > FILL VOLUME
10mL, 50mL, 75mL



HCTMi

FEATURES

This tottle is perfect for pairing with sun care formulas.

- > MATERIALS
Bottle: PE+Adhesive+EVOH (3 layers) or PE
Cap: PP
Plug: LDPE

- > FILL VOLUME
8mL, 15mL, 50mL,
70mL, 110mL



HCTNe

FEATURES

This tottle is perfect for pairing with sun care formulas.

- > MATERIALS
Bottle: PE+Adhesive+EVOH (3 layers) or PE
Outer Cap: ABS or PP
Inner Cap: PP
Plug: LDPE

- > FILL VOLUME
40mL, 50mL



HCT201-015P

FEATURES

This airtight compact is perfect for preserving precious formulas.

> MATERIALS

- Lid: ABS
- Engine (lid): PP
- Engine (Base): PE
- Button: PC
- Body: ABS

> FILL VOLUME

15mL



HCT201-030

FEATURES

This airtight compact is perfect for preserving precious formulas, and the size is great for body use.

> MATERIALS

- Lid: ABS
- Case: ABS
- Engine (lid): PP
- Engine (Base): PE
- Button: PC

> FILL VOLUME

30g



PICTURA KIT

FEATURES

The Pictura Kit combines cutting-edge airless technology with a versatile base, to create a pump that is a great option for both color cosmetic and skincare formulations.

- > MATERIALS
 - Actuator: ABS
 - Actuator Cover: PP
 - Tip: PP
 - Shoulder Cap: ABS
 - Bottle: PETG
 - Bottle Piston: PE
 - Bottle Base: ABS
 - Bottle Cap (Applicator Holder): ABS

- > FILL VOLUME
 - 30mL
- TOOLING
 - Production

HOT & NEW



PICTURA KIT WITH JAR

FEATURES

The Pictura Kit with Jar combines cutting-edge airless technology that is a great option for both color cosmetic and skincare formulations. This multitasking, 2-in-1 component features a pump and jar attachment

- > MATERIALS
 - Actuator: ABS
 - Actuator Cover: PP
 - Tip: PP
 - Should Cap: ABS
 - Bottle: PETG
 - Piston: PE
 - Jar: PETG
 - Jar Cap: PP
 - Seal Plate: PE

- > FILL VOLUME
 - Bottle: 30mL
 - Jar: 20mL
- TOOLING
 - Pilot

**TURNKEY +
FORMULATION**



FORMULATION

WITH HCT'S LATEST TECHNOLOGIES AND GLOBAL TREND FORECASTING, WE ARE ABLE TO PAIR ALL COMPONENTS WITH A VARIETY OF COMPATIBLE COLOR COSMETICS AND SKINCARE FORMULATIONS.

AVAILABLE FORMULATIONS

SKINCARE	COLOR COSMETICS	BODY AND HAIR CARE	OTHER
 CLEANSERS	 PRIMER	 BODY PRODUCTS	 QUASI DRUG PRODUCTS
 TONER	 LIQUID FOUNDATION	 HAIR PRODUCTS	 BABY PRODUCTS
 OIL	 CUSHION FOUNDATION		 PERFUME PRODUCTS
 EYE PRODUCT	 CONCEALER		
 ESSENCE	 BB / CC CREAM		
 EMULSION	 EYEBROW		
 CREAM	 EYE SHADOW		
 MASK	 MASCARA		
 SHEET MASK	 EYELINER		
 SUNBLOCK	 BLUSHER		
 ANTI-WRINKLE PRODUCT	 CONTOUR		
 WHITENING PRODUCT	 LIPSTICK		
 FACIAL MIST	 LIP GLOSS / TATTOO		
 LIP BALM	 LOOSE POWDER		
 LIP & EYE REMOVER	 PRESSED POWDER		



OFFICE LOCATIONS

LOS ANGELES

2800 28th Street, Suite 240
Santa Monica CA 90405
Tel: 310.260.7680
E: info@hctusa.com

NEW YORK

600 5th Avenue, 15th Floor
New York, NY 10020
Tel: 212.586.0303
E: info@hctusa.com

NEW JERSEY

46 East Main Street, Suite 202
Somerville, NJ 08876
Tel: 908.203.8610
E: hct@hctusa.com

PARIS

3 rue la Boétie,
75008 Paris, France
Tel: +33 (0)1 71 22 40 00
E: info@hctgroup.com

HONG KONG

23rd Floor, West Exchange Tower,
322 Des Voeux Road Central
Sheung Wan, Hong Kong
Tel: 852.3622.5090
E: info@hctasia.com

SHANGHAI

Room 903, Tower C
No. 518 Shen Chang Rd.
Minhang District, Shanghai,
201107, China
Tel: +86 21 6228 2866
E: info@hctgroup.com

SEOUL

30 FI POSCO Tower Songdo
165 Convensia Daero
Yeonsu-gu, Incheon
21998 Republic of Korea
Tel: +82 10 3439 3225
E: info@hctgroup.com

LONDON

Second Floor Pepys Court
84086 The Chase
London, UK SW4 0NF
Tel: +44 (0) 20 7720 8206
E: info@hctgroup.com

HCT
by kdc/one

LOS ANGELES | NEW YORK | NEW JERSEY | LONDON | PARIS | HONG KONG | SHANGHAI | SEOUL

hctgroup.com | info@hctgroup.com | [@hct.group](https://www.instagram.com/hct.group)